

**ROY X**

**• USER •  
MANUAL**



**S  
W  
I  
S  
S**

**M  
A  
D  
E  
+**

**COMBO AMP FOR ACOUSTIC INSTRUMENTS**



**SCHERTLER**



**V I E N**

**W W W . S C H E R T L E R . C O M**



# INTRODUCTION

Thank you for choosing the **ROY X** amplifier. ROY X represents the state of the art in Swiss amplifier design, reflecting all the needs of the user. Offering a significantly improved power amp and speaker section, together with a crossover filter network, limiter and gain, this versatile 7-channel combo amplification system offers 450 W (124 dB SPL) of bi-amplified power. Equipped with a 1" dome tweeter and two 8" woofers, it has been engineered with an optimized 2-way bass reflex system.

ROY X is highly effective as a stand-alone portable system for soloists or small groups. The system can accommodate various mic/instrument combinations and offers a comprehensive mixing facility for easy on-stage setup. ROY X's master section includes both a spring-like reverb with decay and a digital multi-effect module (on a separate bus). A headphone preamp provides a handy monitoring facility.

SCHERTLER amps feature a sophisticated Class-A preamp with no integrated circuits and No Negative Feedback (NNFB), resulting in unparalleled dynamics and fast transient behavior.

To make the most of your ROY X amplifier and to ensure trouble-free operation, **please read this manual carefully** before using the amp for the first time. We also advise keeping the manual for future reference.

# IMPORTANT SAFETY INFORMATION

## SAFETY FIRST!

Safety is of major importance when operating any electrical equipment, so please note the following:

On a product, a lightning flash within a triangle indicates the presence of uninsulated “dangerous voltage” within the product enclosure. This may be of sufficient magnitude to cause risk of electric shock.

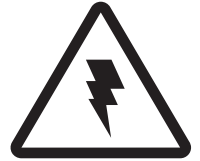

## ELECTRICAL SAFETY

- Before connecting your amplifier to the mains, make sure that the mains voltage does not exceed the voltage specified on the device.
- Do not use your amplifier if its mains cable or plug are not in perfect condition. Replace these as necessary. The replacement cable must be the same as the original.
- Your amplifier should only be connected to a mains socket with a ground protection system.
- When using or installing your amplifier, make sure that the mains socket and the amplifier’s mains cable and plug are easily accessible.
- Do not, under any circumstances, defeat the safety purpose of the polarized or grounding-type plug. A polarized plug has two blades with one wider than the other. A grounding-type plug has two blades and a third grounding prong. The wide blade and third prong are provided for your safety. If the supplied plug does not fit your mains socket, consult an electrician for replacement of the obsolete socket.
- Do not expose your amplifier to rain or any other water (even in small amounts). Do not use the amplifier near water.
- Avoid spilling drinks or any other liquids on the amplifier.
- Do not operate your amplifier in excessively humid conditions. Avoid excessive heat from sunshine, fire or similar. If the amp is being used in a dusty environment, make sure it is adequately protected.
- Avoid using or installing your amplifier near any heat sources such as radiators, heat registers, stoves, or other heat-producing apparatus. Do not put any sources of open flame (e.g. candles or pyrotechnics) on or near the amplifier.
- Do not cover your amplifier during use, or obstruct the ventilation flow in any way.
- Always leave sufficient clearance between the heat sink and any other surface.
- Unplug your amplifier during lightning storms, or if it is not going to be used for a while. (Remove the plug from the mains socket to completely disconnect the amplifier.)
- Your amplifier does not contain any “user serviceable” parts. Servicing and/or repairs should only be carried out by qualified personnel. See MAINTENANCE AND REPAIR.

## OPERATIONAL SAFETY

- During installation or live performances, make sure that your mixer's power supply cable cannot be walked on, tripped over or "pinched" – particularly at sockets, around waste bins etc. Also make sure that the power supply cable is not "stressed" at its point of connection to the mixer.
- To avoid interference, do not install your mixer near power transformers, TV sets, RF transmitters, electric motors, or any other sources of electrical energy.
- To avoid potential accidents, only use attachments, accessories and other equipment such as carts, stands, tripods, brackets or cases that are specified or recommended by the manufacturer, or sold with your mixer.
- Loud volume levels can cause irreparable damage to hearing, so avoid the following while using your mixer:
  - acoustic feedback (never point microphones directly at a loudspeaker)
  - high levels of distortion
  - impulse noises (loud "pops") that can occur when a device is switched on/off, connected to or disconnected from a system.

## MAINTENANCE AND REPAIR

- Your mixer can be carefully cleaned, as necessary, using a dry cloth. No water must be used.
- When cleaning, do not use any solvents (such as acetone or alcohol). These could damage the mixer's finish and its labeling.
- Visually check your mixer on a regular basis for any signs of wear and tear or damage, but do not attempt any kind of servicing or repair.
- If your mixer malfunctions, or has been damaged, e.g. if the power supply/cable or plug is damaged, liquid has been spilled or objects have fallen inside, the mixer has been exposed to rain or moisture, does not operate normally, or has been dropped, please call your nearest SCHERTLER technical assistance centre. (For more information, contact us at the address on the last page of this manual.)

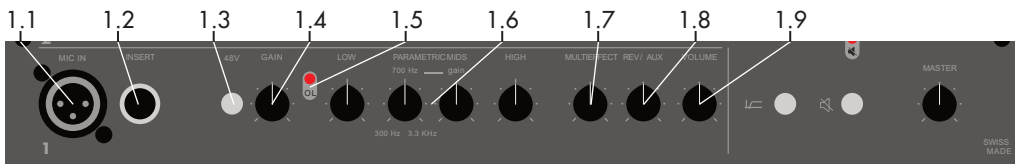

1.1. **MIC INPUT (XLR):** This input is electronically balanced for XLR-type connections. The channel is designed for any kind of microphone source e.g. dynamic and condenser mics.

1.2. **INSERT:** This stereo jack socket enables the connection of an external device (compressor, equalizer, etc.) in series to all the outputs.

1.3. **48V:** Phantom power supplies the XLR connector with 48 VDC for powering condenser microphones. Most condenser (and dynamic) mics, and some preamps, can be safely phantom powered. In certain cases however, phantom power can cause damage. This tends to happen with unbalanced microphones, preamps, or stompboxes that have been modified for balanced XLR use. If in doubt, please contact the manufacturer to check the compatibility of your audio device before using the amplifier.

1.4. **GAIN:** This variable gain preamplifier adjusts the sensitivity level to ensure the best possible processing of the signal through the channel. It is important that this input level is set and optimized in the best way to achieve the cleanest sound possible.

1.5. **OVERLOAD:** This LED (when lit) indicates that the level of the input signal is too high and it might therefore introduce distortion.

Practical tip: When using an amplified speaker, distorted input signals should be avoided at all cost in order to prevent potential damage to the speaker. While playing or singing, carefully set the preamp/gain level by turning up the GAIN control until the OVERLOAD LED begins to blink. At this point, turn the gain back down slightly. Now set the MASTER Volume between 30% and 60%. With the gain and master levels appropriately set, you can now set the channel volume as you please.

1.6. **HIGH, MID, LOW (EQ):** These controls are for high, mid and low frequency regulation. Offering cut and boost of  $\pm 15$  dB, they allow a wide range of tonal variations to be explored. Parametric MID regulation offers the possibility to cut or boost a frequency range between 300 Hz and 3.3 kHz. When the controls are positioned centrally there is no cut or boost of the selected frequency band.

1.7. **MULTIEFFECT:** This rotary control sets the level of the selected effect on the channel.

1.8. **REV/AUX:** This rotary control sets the level of the digital reverb on the channel and the level of the signal to the AUX OUT output. If you want to bypass the onboard reverb, you can set the REVERB Master control to zero and use the REV/AUX to control the amount of signal you want to send to an external effect unit, or to an additional monitor.

1.9. **VOLUME:** This rotary control regulates the channel volume.

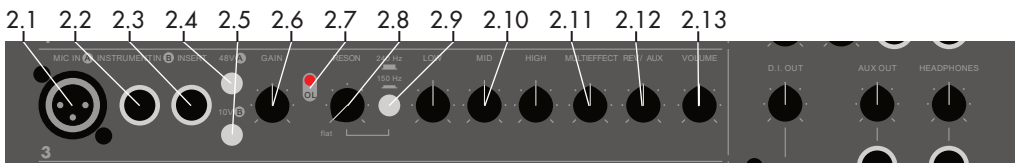

2.1. MIC INPUT (XLR): This input is electronically balanced for XLR-type connections. The channel is designed for any kind of microphone source e.g. dynamic and condenser mics.

2.2. INSTRUMENT IN: An unbalanced input for the connection of 1/4" jacks, with optimal sensitivity for high level signals. The electronics will adapt to any situation - no special action is required.

2.3. INSERT: This stereo jack socket enables the connection of an external device (compressor, equalizer, etc.) in series to all the outputs.

2.4. 48V: Phantom power supplies the XLR connector with 48 VDC for powering condenser microphones. Most condenser (and dynamic) mics, and some preamps, can be safely phantom powered. In certain cases however, phantom power can cause damage. This tends to happen with unbalanced microphones, preamps, or stompboxes that have been modified for balanced XLR use. If in doubt, please contact the manufacturer to check the compatibility of your audio device before using the amplifier.

2.5. 10V: This supplies the jack connector with 10 VDC for powering electret microphones.

2.6. GAIN: This variable gain preamplifier adjusts the sensitivity level to ensure the best possible processing of the mic/instrument signal through the channel. It is important that this input level is set and optimized in the best way to achieve the cleanest sound possible.

2.7. OVERLOAD: This LED (when lit) indicates that the level of the input signal is too high and it might therefore introduce distortion. (See "Practical tip", 1.5.)

2.8. RESON: The RESONANCE (notch) filter cuts the frequency of 150 Hz/240 Hz, to reduce low-frequency feedback. Left: no attenuation (flat), Right: maximum attenuation.

2.9. RESON button: Use the RESON button to select the resonant frequency of the instrument (240 Hz/150 Hz).

2.10. HIGH, MID, LOW (EQ): These controls are for high, mid and low frequency regulation. Offering cut and boost of  $\pm 15$  dB, they allow a wide range of tonal variations to be explored. When the controls are positioned centrally there is no cut or boost of the selected frequency band.

2.11. MULTIEFFECT: This rotary control sets the level of the selected effect on the channel.

2.12. REV/AUX: This rotary control sets the level of the digital reverb on the channel and the level of the signal to the AUX OUT output. If you want to bypass the onboard reverb, you can set the REVERB Master control to zero and use the REV/AUX to control the amount of signal you want to send to an external effect unit, or to an additional monitor.

2.13. VOLUME: This rotary control regulates the channel volume.

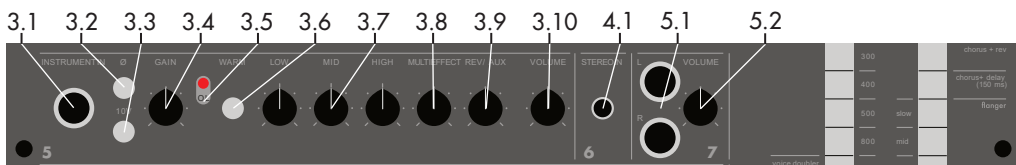

3.1. INSTRUMENT IN: An unbalanced input for the connection of 1/4" jacks, with optimal sensitivity for high level signals. The electronics will adapt to any situation - no special action is required.

3.2. PHASE: In the event of feedback, or unwanted effects between channels, use the PHASE REVERSE button.

3.3. 10V: This supplies the jack connector with 10 VDC for powering electret microphones.

3.4. GAIN: This variable gain preamplifier adjusts the sensitivity level to ensure the best possible processing of the signal through the channel. It is important that this input level is set and optimized in the best way to achieve the cleanest sound possible.

3.5. OVERLOAD: This LED (when lit) indicates that the level of the input signal is too high and it might therefore introduce distortion. (See "Practical tip", 1.5.)

3.6. WARM: When active, this low-pass filter dampens higher frequencies to produce a warmer sound when using bridge-mounted pickups such as the SCHERTLER STAT Series for violin, cello and double bass.

3.7. HIGH, MID, LOW (EQ): These controls are for high, mid and low frequency regulation. Offering cut and boost of  $\pm 15$  dB, they allow a wide range of tonal variations to be explored. When the controls are positioned centrally there is no cut or boost of the selected frequency band.

3.8. MULTIEFFECT: This rotary control sets the level of the selected effect on the channel.

3.9. REV/AUX: This rotary control sets the level of the digital reverb on the channel and the level of the signal to the AUX OUT output. If you want to bypass the onboard reverb, you can set the REVERB Master control to zero and use the REV/AUX to control the amount of signal you want to send to an external effect unit, or to an additional monitor.

3.10. VOLUME: This rotary control regulates the channel volume.

4.1. STEREO IN: 1/8" mini jack stereo input for PC, MP3 and other electronic devices. Volume depends on the MASTER volume regulation.

5.1. FX RETURN: Left and Right unbalanced jack socket for the return of external effects. This can also be used as a 7th input channel to accommodate an extra line level device.

5.2. FX RETURN VOL: This rotary control regulates the channel volume.



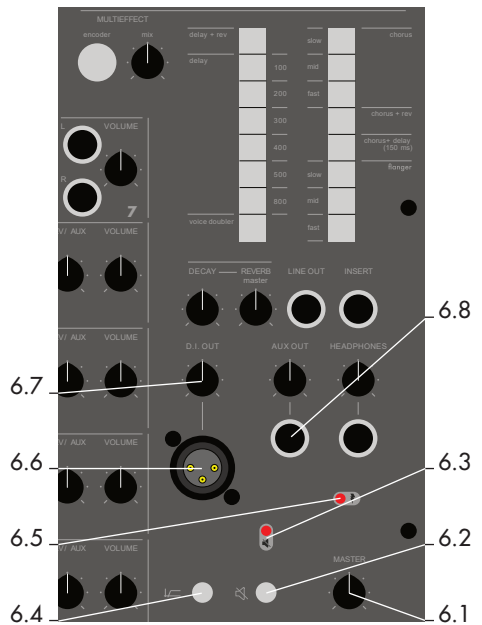

6.1. MASTER: Controls the overall system volume.

6.2. MUTE: This cuts the audio on the Master.

6.3 MUTE LED: This LED indicates when the amplifier is muted.

6.4. LOW CUT: When active, this filter cuts all frequencies below 120 Hz - ideal if you play an instrument that generates aggressive low frequencies. It enables you to connect a subwoofer, and prevent unwanted vibration and possible damage to your ROY X.

6.5. Power LED: This LED indicates when the amplifier is switched ON.

6.6. DI OUT: A general XLR balanced output for connecting to external systems. The output volume does not depend on the regulation of the MASTER control, but is affected by changes in individual channel volume.

6.7. DI OUT Volume: This rotary control sets the output level on the DI OUT.

6.8. AUX OUT: Additional output. This mono jack socket enables connection to other systems. In order to create a secondary mix for a stage monitor or external effect, turn the REVERB Master control (6.14) to zero and use the REV/AUX control on each channel to set the levels. You can still have an internal reverb effect from the MULTIEFFECT (use the MULTIEFFECT control on each channel to set the desired amount of internal effect).

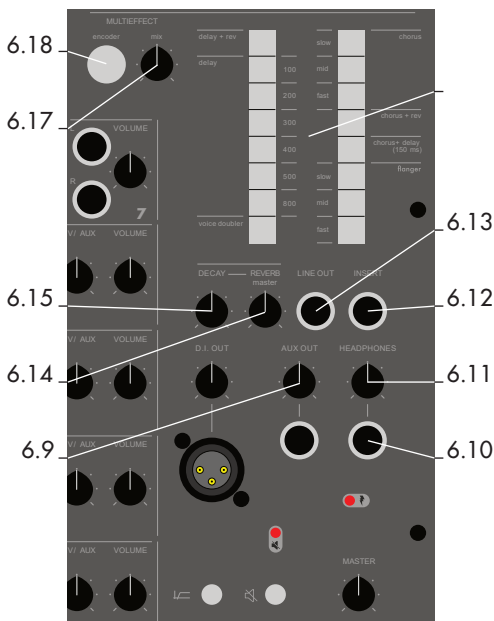

6.9. AUX OUT volume: This rotary control sets the output level on the AUX OUT.

6.10. HEADPHONES: This mono jack socket enables the connection of headphones.

6.11. HEADPHONES Volume: This rotary control sets the output level on the HEADPHONES output.

6.12. INSERT: This stereo jack socket enables the connection of an external device (compressor, equalizer, etc.) in series to all the outputs.

6.13. LINE OUT: This unbalanced jack socket enables the connection of external systems. The output volume depends on the regulation of the MASTER control.

6.14. REVERB Master: This control regulates the general level of the digital reverb, common to all channels. The amount of effect can be individually regulated for each single channel via the dedicated controls.

6.15. DECAY: This control regulates the length of the reverb (reverb time from attack to silence).

6.16. MULTIEFFECT: This panel shows the 16 available internal digital effects. A light indicates which of these effects is currently active.

6.17. MULTIEFFECT MIX: This control regulates the general level of the digital effect, common to all channels. The amount of effect for each channel can be regulated via the individual controls.

6.18. MULTIEFFECT ENCODER: This rotary control selects the internal effect.

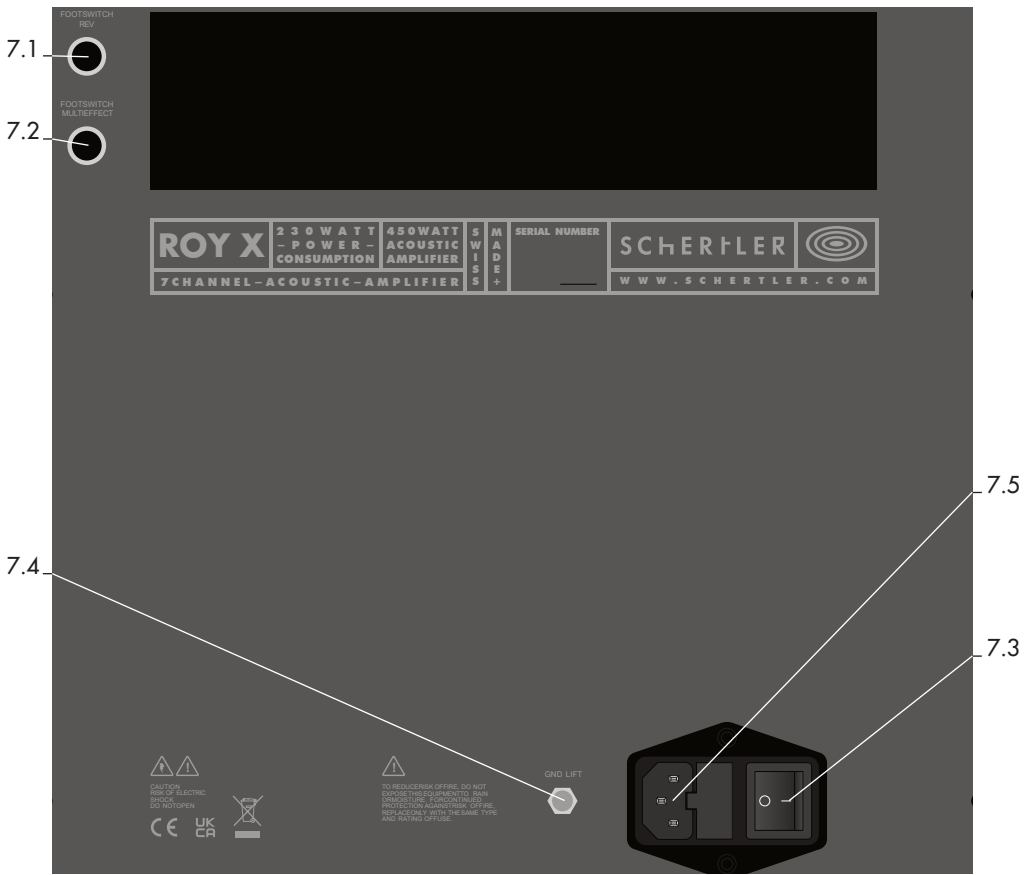

7.1. FOOTSWITCH REV: This 1/4" jack enables the connection of a footswitch to turn the reverb on and off.

7.2. FOOTSWITCH MULTIEFFECT: This 1/4" jack enables the connection of a footswitch to turn the multi-effect section on and off.

7.3. POWER ON/OFF: System ON/OFF switch.

7.4. GROUND LIFT: This switch connects and disconnects the ground.

#### 7.5. MAINS POWER CONNECTION:

Connection to mains		Fuse carrier
220 - 230 V~	50 Hz / 60 Hz	T 1.6 A L 250 V
240 V~	50 Hz	T 1.6 A L 250 V
120 V~	60 Hz	T 3.15 A L 250 V
100 V~	50 Hz / 60 Hz	T 3.15 A L 250 V

PLEASE ENSURE THAT THE CORRECT VOLTAGE IS OBSERVED AND THE ORIGINAL CONNECTION CABLE IS USED

# TECHNICAL INFORMATION

Weight	22.2 kg
Dimensions (LxDxH)	35.7 x 41.5 x 51 cm
Frequency Response (@ +/-3dB)	40 Hz to 20 kHz
Sensitivity (1W/1m) @1 kHz	95 dB
Power	450 W Class-D power amp
SPL Max	124 dB
Speakers	1" compression driver, 2x 8" woofer
Construction	15 mm birch BB laminated
System - Format	Two way, bi-amplified - Bass reflex
Mic In connector	XLR
Mic In sensitivity	-52 dB
Mic In impedance	9.4 k $\Omega$
Instrument In connector	1/4" jack unbalanced
Instrument In sensitivity	-47 dB
Instrument In impedance	820 k $\Omega$
Stereo In connector	1/8" jack stereo
Stereo In sensitivity	-10 dBu
Stereo In impedance	44 k $\Omega$
Insert	On master + channels 1-4
Line Out connector	1/4" jack
Line Out level	0 dBu
Line Out impedance	200 $\Omega$
DI Out connector	XLR
DI Out level	$-\infty$ to +6 dBu
DI Out impedance	180 $\Omega$
Aux Out connector	1/4" jack unbalanced
Aux Out level	$-\infty$ to 0 dBu
Aux Out impedance	180 $\Omega$
Phones connector	1/4" jack stereo
Phones level	12 dBu
Phantom Power (nominal)	48 VDC
Stat Power (10 VDC)	Yes
Effect	Spring-type digital reverb with decay + parallel multi effect section with 16 presets
Preamp	Class-A, no negative feedback, no integrated circuits
Footswitch	For multi-effect section and digital reverb
Stand mounting	n.a.
Available versions	Dark wood and anthracite

**AMPS**

**ACOUSTIC X**

# SIGNAL FLOW

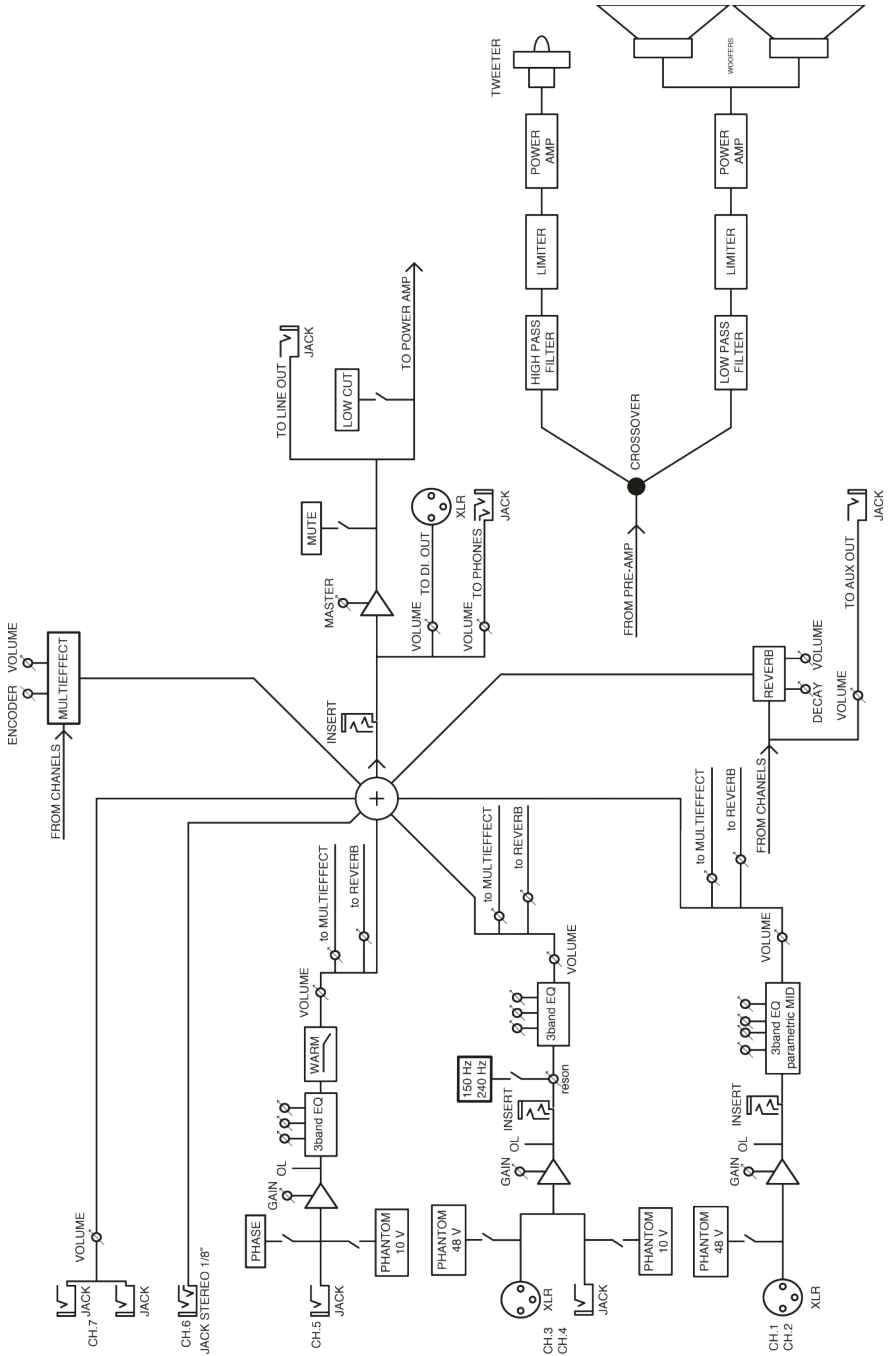

# FAQ

Where can I buy amplifier bags/accessories?

Amp bags, along with other SCHERTLER product accessories, are available from the online web shop at [www.schertler.com](http://www.schertler.com). You can buy the product itself and/or its accessories from the relevant product page.

Can I get a copy of this manual in other languages?

Digital versions of our manuals are available in English, Italian, German and French. These can be downloaded from the product pages of the SCHERTLER website: [www.schertler.com](http://www.schertler.com)

Can I bypass the internal power supply and power the amp via battery?

No, our amplifier electronics are designed for mains use only. It is not possible to modify the amp for "battery powering". You could however connect the amp to an external voltage compatible battery that can accommodate the amp's supplied power cable/plug.

Does the I/O INSERT allow you to put effects on all channels?

Yes, the INSERT connection works on the Master, so it affects all the channels.

How do I make the connections to use a second speaker or amplifier?

The easiest way to connect an external speaker (or a second active amp) is via the LINE OUT or DI OUT.

What is the best way to connect a delay or other external effect to my ROY X?

If you only have one instrument connected to your amp, you can use the master section INSERT. For this connection you will need a Y insert cable. Another way of connecting the external effect is in series: the effect must be in the chain just before the signal enters the amp (guitar → pedal → amp). A third option (maybe the best) is to use the amplifier's AUX OUT. This is the parallel send that sends the signal to the internal reverb as well. By using the AUX OUT you can feed your delay input and continue using the internal reverb. The channel effect send will be the same for both the external effect and the internal reverb. You will be able to set the amount of the effect/reverb using the returns.

# APPENDIX

## WARRANTY

All SCHERTLER products are covered by a limited two-year factory warranty in respect of manufacturer defects. Details can be obtained from your local dealer / representative.

SCHERTLER SA strongly believes in "common sense". Therefore, misuse of our products is not covered under rights obtained through our warranty policy, or through internationally recognized terms and conditions. For more information on warranty, please visit the General Condition's page at [www.schertler.com](http://www.schertler.com)

## PRODUCT DISPOSAL

This product must not be disposed of in general household waste. It should be taken to a disposal center for electrical / electronic waste. Please note any local or national regulations that may be applicable here.

## TRADEMARKS

The SCHERTLER® name and logo are registered trade names / trademarks of SCHERTLER SA Switzerland. All SCHERTLER® products use proprietary technology and are covered by one or more worldwide patents.

## DISCLAIMER

All information and technical specifications published here are based on data that was available at the time of publication. SCHERTLER is, however, constantly aiming to improve its range of products and therefore reserves the right to amend product specifications and information without notice. SCHERTLER takes no responsibility for any direct or indirect damage (including loss of profit), which arises as a result of, or in connection with the information in this manual.

## COPYRIGHT

This manual is the property of SCHERTLER SA and, as such, is subject to Swiss copyright law. No part of this manual should be reproduced, edited or distributed without prior consent from SCHERTLER.



ACOUSTIC  
· AUDIO ·  
PRODUCTS

S  
W  
I  
S  
S



SCHERTLER



M  
A  
D  
E  
+

VIA BEROLDINGEN 18  
6850 HENDRISO  
SWITZERLAND  
T +41 (0) 91630 0710  
F +41 (0) 91630 0711  
INFO@SCHERTLER.SWISS  
WWW.SCHERTLER.COM